

# railways

The customer magazine of DB Cargo



04/20



FOCUS

# Future

For the climate. Without climate protection, there is no future.  
Tomorrow is being made right now. DB Cargo has already set the path.

→ Page 10

# Editorial



**Dear Readers,**

2020 was a challenging year for people, the economy and, last but not least, the climate. The pandemic may have temporarily pushed the environmental debate into the background, but saving the planet is more important for our future than ever. Consumers have been rethinking their relationship with the environment for some time, and now the worlds of business and politics are following suit. Carrying on as before is no longer an option. Road traffic is on the verge of collapse, and CO<sub>2</sub> emissions must be reduced. This is only possible with strong rail to secure our future. After all, there is no means of transport with greener credentials than rail.

In this issue, you can read about what our logistics operations need to look like in the future, what businesses and politicians are already doing, and what contribution we are making.

I hope you find it interesting reading.

Yours sincerely,

A handwritten signature in blue ink, appearing to read 'Pierre Timmermans'. The signature is fluid and cursive.

**Pierre Timmermans**  
Board Member for Sales, DB Cargo AG



— *We must act now, or the consequences will be dramatic and felt all around the world.*



# For the future

02

Editorial

04

Contents

08

Inside



— Rail freight transport will be even more important for future supply chains.

FOCUS

10

## Here's how the future works!

What will logistics and consumption look like in the future? A journey to the year 2050.

16

## The future of logistics

An interview with futurologists Professor Peter Holm and Karl-Heinz Land.

20

## Act. Shift your cargo. Now.

What business, politicians and the DB Group are already doing to ensure sustainability.

26

## To the Far East with low emissions

How goods can be transported between China and Europe in a more environmentally friendly way.

30

## Goodness, gracious, waste bales on fire!

Clever rail logistics solution for Scandinavia, Italy and the environment.



04/20



— DB Cargo transports goods via the Eurasian corridor all the way to China.

#### CUSTOMERS & MARKETS

### 32

#### These arguments for rail are as strong as steel

Welser Profile relies on DB Cargo to deliver its special steel profiles.

### 34

#### International and flexible

DB Cargo transports vehicles all across Europe for Ford.

### 38

#### A well-received logistics package

A new Europe-wide transport concept for Evonik's speciality chemicals.

### 40

#### Running like a well-oiled machine

DBrail pipeline offers flexibility and stability for the mineral oil industry.

#### INNOVATIONS & SOLUTIONS

### 42

#### A new era

DB Cargo and VW are preparing for the future with a vast network for climate friendly transport.

### 50

#### Just what is the job of ...

... a sustainability manager at DB Cargo?

### 51

#### Looking ahead & publishing details



Visit our website and subscribe to our newsletter: [www.dbcargo.com/newsletteranmeldung](http://www.dbcargo.com/newsletteranmeldung)

## AWARDS

Our customer magazine has won Gold at the FOX AWARDS and an Award of Excellence at the ICMA Awards.





# Wherever you are, we're there too.

---





NETWORKS

## We can do it!

Even in the mountains! Or by the sea. We're even there for you on the worldwide web – virtually. We've got content that is humorous and serious, important and entertaining, and always full of genuine enthusiasm for rail freight transport.

Here's where to find us:



[dbcargo.com](https://dbcargo.com)



[dbcargo.com/newsletter](https://dbcargo.com/newsletter)



[DB\\_Cargo](https://twitter.com/DB_Cargo)



[company/db-cargo-ag](https://company/db-cargo-ag)



[db\\_cargo](https://www.instagram.com/db_cargo)



[dbcargooffiziell](https://www.facebook.com/dbcargooffiziell)



[companies/deutschebahn-dbcargoag](https://companies/deutschebahn-dbcargoag)





*— In 2019, around 400,000 tonnes of recycled ballast were used in the upgrading and maintenance of tracks.*

CLIMATE-FRIENDLY FACTS

**Did you know ...**

... that green electricity makes up 60% of DB's traction current mix? That proportion is far higher than in the public grid.

... that efforts to shift traffic to rail are aimed at curbing total CO<sub>2</sub> emissions by up to 10.5 million tonnes a year? This figure is equivalent to the annual CO<sub>2</sub> footprint of one million people.

... that the goal of Strong Rail for passenger transport is to double ridership on long-distance services to 260 million and add a billion more passengers in regional and local transport, eliminating five million car journeys and around 14,000 plane trips every day in Germany?

... that DB has given a new home to over 56 million bees on DB land?

... that DB trains all locomotive drivers in energy-saving driving techniques, reducing energy consumption by up to 10%? •

**60%**

of DB Cargo traffic crosses at least one national border

**1,900**

smart locomotives already send automated status reports on their condition

**1 million**

tonnes of goods are transported by DB Cargo by rail through Germany and Europe every business day



— DB Cargo couples up 54,000 wagons and trains in Germany every day.

EVPLUS

## New door-to-door solution

EVplus is a new single wagonload product between Hamburg and Cologne developed by DB Cargo: door-to-door delivery by fast overnight service – it provides easy access to the rail network, even for customers without their own siding.

The new EVplus product stands for the integration of wagonload and intermodal transport and is the first product to offer systematically combined transport in the single wagonload system. The customer can leave everything to us: DB Cargo Logistics takes charge of organising every aspect of the service, including first and last mile deliveries by lorry and the provision of equipment such as 45-foot swap bodies.

Since the product launched, pilot customer Coca-Cola has been leveraging the new offer on a daily basis to handle smaller cargo volumes simply and sustainably by rail. What started with Coca-Cola is also available to all other customers of DB Cargo. Intermodal transport is in high demand especially in the consumer goods market. Other routes are set to follow from 2021 with a long-term view to connecting all the economic centres in Germany. ●



Stephanie Reinert,  
Head of Consumer Goods, DB Cargo,  
[stephanie.reinert@deutschebahn.com](mailto:stephanie.reinert@deutschebahn.com)

PILOT PROJECT

## Digital automatic coupling

This year, DB Cargo has been testing digital automatic coupling (DAC) in marshalling yards in Görlitz to create more capacity on the railways. DAC automatically connects pairs of freight wagons and speeds up the train formation process. It also reduces the physical workload for railway staff: DAC will make manual screw couplings, which have been used to couple almost all European freight trains for over 100 years, a thing of the past.

DAC is ushering in a broad digitalisation of rail freight transport and is an important part of efforts to boost transport performance by some 70% or more. Running until the end of 2022, the project was commissioned by the German Federal Ministry of Transport and Digital Infrastructure, which has also provided funding to the tune of EUR 13 million. Apart from DB and its subsidiary DB Cargo, five other European freight operating companies are also involved. ●





# Here's how the future works!





Often we don't notice a turning point until we look back. 2020 was one such point, the height of a trend that started with industrialisation and seemed unstoppable by the mid-20th century.

Rainforests burned on an unprecedented scale. Factory farming, environmental pollution, the coronavirus pandemic and ravenous consumption of resources by nearly eight billion people pulled the planet to the brink of collapse. Yet this was also the start of a development that would ultimately deliver completely carbon-free and sustainable supply chains and consumption.



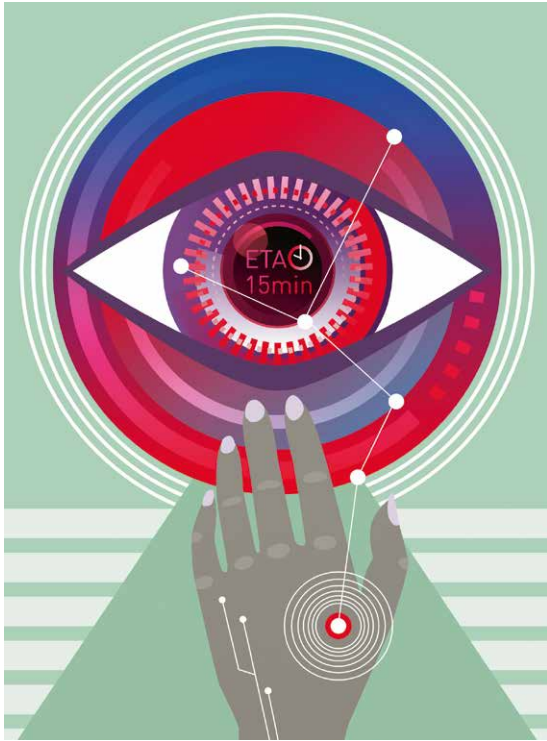

## “Implantables and biohacking: In 2050, messages will be projected directly onto your retina.”

In 2050, no one can say for sure whether it was the pandemic that opened people’s eyes or the Fridays for Future demonstrations that finally yielded results. The fact remains, though, that life has changed radically in the last 30 years because people themselves have changed. Suddenly, living sustainably is more than just the latest hip thing to do—it’s taken deep root in people’s consciousness. Emma doesn’t take it for granted, though. Back in her school days, she took part in the Fridays for Future movement herself. The movement set its sights high, but nobody would have ever believed that one day Greta Thunberg would be the Environment Commissioner of the European Union. In 2050, it is now an EU that truly deserves to be called a community, a union working together to draw up and implement binding

decisions for the entire continent. What a difference they made back then! Today, Emma is supply chain manager for logistics at EcoCon, the leading consumer goods group, and is actively helping to shape what she and her fellow campaigners took to the streets for 30 years ago. A gentle vibration on the back of her hand interrupts her thoughts and tugs her out of the past and back to the present—her chip implant is signalling an incoming message. Once she confirms, the message is projected directly onto her retina: “Your DB Cargo shipment is arriving in exactly 15 minutes.”

### Vegan and carbon-free

After all, supply chains in 2050 are not only completely carbon-free; they are also absolutely reliable and accurate to the minute. A comprehensive rethinking of policy was what made this all

possible. The major crises of the early 2020s paved the way for the first green German government and even the first green Federal Chancellor. Even more surprising was that almost all the opposition parties suddenly recognised the urgency of the situation and pulled together. Railways were expanded, there was a push to accelerate a clever mix of transport modes, and last but not least, digitalisation was fully embraced and took a giant leap in the mid-2020s. Since then, logistics has been inconceivable without artificial intelligence. Companies like EcoCon reaped the benefits, too; without zero-carbon transport they couldn’t even exist on the market. In addition to sustainable silphium honey, the group offers a selection of purely vegan products. Amid the 2020 coronavirus pandemic, even the most die-hard sceptics came to realise that factory farming had simply become untenable. There was already a trend towards vegetarian food back at the turn of the century, though it failed to fully catch on at first. Now it would be unthinkable to practise factory farming or ship and slaughter animals under cruel conditions. It took a while to turn the corner, but 15 years ago EcoCon really found its stride, even manufacturing artificial protein in small regional laboratories. The feat rendered factory farming obsolete in a single stroke, while also significantly reducing the huge swathes of land lost to water-hungry and energy-guzzling farming. In their place, forests were replanted and rivers restored; the climate recovered noticeably. The artificial proteins eventually enabled researchers to churn some staple foods out of a 3D printer. What had already become mainstream in industry by the end of the 2020s went on to revolutionise the consumer goods sector, too. People started transporting things much less and with much more awareness of the environmental impact. Now, products are transported from laboratory centres to stores exclusively by zero-carbon rail, with most of the lines laid underground. As a result, freight transport was fully decoupled from passenger transport by the end of the 2030s. Traffic flows immediately became ▶



**“In the future, artificial proteins will enable us to pull staple foods out of 3D printers on demand.”**



**“More or less in person: Holographic avatars are so real that travelling is almost unnecessary.”**



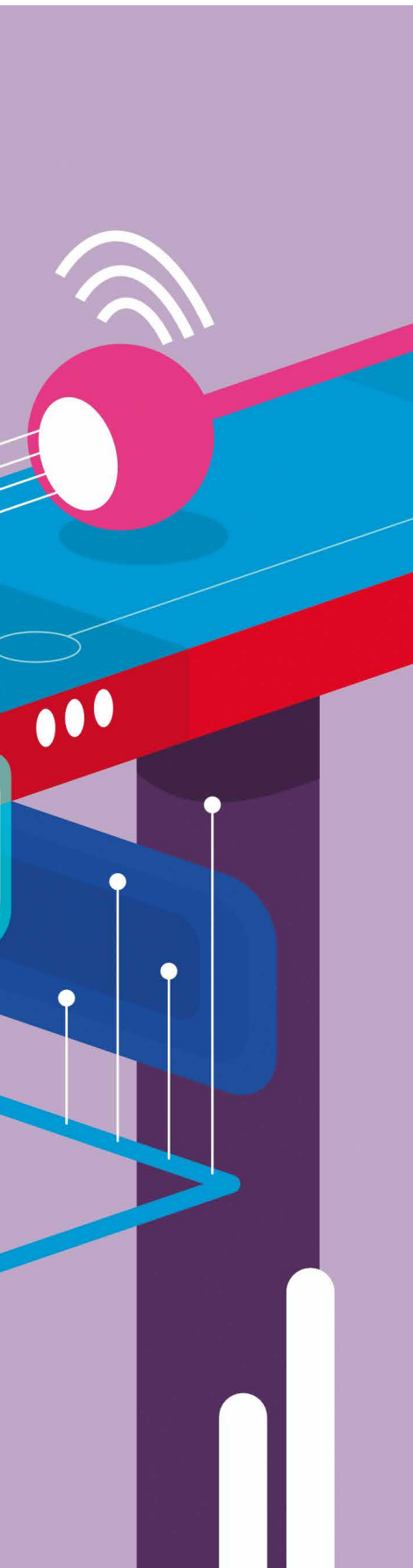

► safer and more reliable. This was also due to the automation of all transport. That step was the only way to achieve true efficiency. Since then, errors and accidents have been few and far between, and artificial intelligence has been nearly flawless at planning the massive flows of goods. What's more, all major cities have dedicated underground rail sidings for distributing supplies. Only more rural areas still need transshipment points; the last mile is served by drones or hydrogen-powered, self-driving lorries, depending on the cargo volume. Emma's store is fortunately big enough.

### Fully automated delivery in an underground company station

The locomotive glides into the station with barely a sound and stops with millimetre precision. Emma's chip vibrates again as she takes the elevator down to the track, but unloading is fully automatic, too. Holograms display data about the delivery: the size and weight, the number of pallets and robots needed for unloading, and the train's departure time. After a quick check and an automated comparison against the order, solar-powered robots unload precisely the quantities that are needed – with absolute exactitude. However, the artificial intelligence doesn't just calculate how much product Emma's store goes through in a day. Three decades of machine learning have practically erased the concept of overproduction. Nothing is ever produced that won't actually be consumed. The resource waste of the 20th century is now finally a thing of the past. Emma watches with satisfaction as the wagons are emptied out and her mechanical colleagues collect and assemble the goods. She observes every step very closely. The technology may be well engineered, but it still doesn't hurt for a human to give it a random check every now and again. She checks, for example, whether the right quality seals are on the goods. There is one for carbon-free transport and another for fair and environmentally friendly production. Emma makes her way home on a bicycle. It's

a very old-fashioned choice, almost nostalgic, with no electrical assistance. Now that there is barely any private transport, city centres have become a paradise for pedestrians and cyclists. Emma lives in a particularly green neighbourhood, where each house facade is planted with algae. It wrings the last bit of CO<sub>2</sub> from the atmosphere while also insulating residents from the heat and cold. The front door opens automatically when Emma reaches the entrance. Her daughter Carly is already waiting for her in the kitchen: "At school today we had to separate our own garbage to learn how the robots always do it. Super yucky!" "You don't know how good you have it, Carly," Emma replies with a laugh. Even Emma's mother, who now lives in South Africa but visits the family virtually every day as an avatar, can't suppress a smile. "Let me tell you what your mother had to do to save us and the planet when she was your age. In those days they used to compress the rubbish and drag it halfway through Europe to the incinerator – but at least that meant it didn't end up in some Asian landfill." Carly shakes her head in disbelief – how primitive! Meanwhile, researchers are increasingly talking about breakthroughs and the first tangible successes at beaming. That would totally transform logistics, taking it into the world of information and data logistics. There would be a need and an opportunity to redesign a lot of things from the ground up. Emma, at any rate, likes that idea. ●

# The future of logistics





## What changes is the logistics industry poised to encounter and how can the industry become even more sustainable? An interview with futurologists Karl-Heinz Land and Professor Peter Holm.

**The German government has set targets for transportation in its climate protection programme. The aim is to put a price on CO<sub>2</sub> emissions and cut them by 40% while electrifying transport and shifting cargo to rail. Are these goals too ambitious or not ambitious enough, in your view?**

— **LAND** Frankly, I find these requirements to be a bit of a disgrace. We aren't challenging industry enough, and if you ask me, they've set the price of CO<sub>2</sub> so low you have to dig for it. I am an outspoken believer in the circular economy and I think everything has its true price. Plastic bottles should never have cost less than glass ones. That's why things will probably take a very long time to happen.

— **HOLM** I think it's great that policymakers are setting goals, and I find them ambitious. However, I also think it's crucial to have even more interplay between various modes of transport to combat climate change. It will take more than a carbon price if we really want to significantly reduce CO<sub>2</sub>; for instance, we would need a digital infrastructure and for society as a whole to step in. We need to tackle this issue on a broader front.

**It seems like it's trendy to be considered green in our society. But are people ready to pay the "true" price for things?**

— **HOLM** There are several examples where this is the case. In Austria, for instance, there is a platform where

consumers are willing to pay more for products transported regionally and sustainably. Thanks to Greta, we have more awareness today. It remains to be seen how ready people are – and especially how willing they are to pay.

— **LAND** That's the chicken-or-the-egg problem. There's no question our consumers are spoiled. In other EU countries, people are more willing to spend more money on groceries. That point will take some practice here. But you can explain it to people and show them: if you do this, here's what will happen. We'll all be very grateful to Greta some day, because that's exactly what she is doing. Now we need to take the next few steps and explain that this transition won't be free.

**Where is there economic potential still waiting to be tapped?**

— **HOLM** Right now, 75% of all goods are transported by road. Our existing infrastructure is approaching its limits in this regard. However, there are some initiatives to shift more freight to the rails and step up combined transport. Railway.tools is a platform which aims to improve interfaces between road and rail. The platform was launched by Bundesverband Güterverkehr Logistik und Entsorgung (BGL), a Germany-wide association for freight transport, logistics and waste management, and the Pro-Rail Alliance. Overall, the issue is highly complex, and the process will take many years. Uniform norms and standards would be helpful. To make rail freight transport more sustainable, we should focus

more on the efficiency gains and innovative power of digitalisation: sensors, platforms and hubs. We're just getting started on that front and we need to keep going.

— **LAND** I agree completely, especially when we look at platforms and the sharing economy. The evidence shows that smart systems use 70-90% fewer resources. Artificial intelligence (AI) will provide enormous leverage in this arena. Digitalisation is an important step towards greater sustainability, and this is where the business sector needs to take action first.

**Do companies need to employ offensive tactics or should they wait for demand for sustainable solutions to grow? Put another way, does the onus of sustainability fall to companies or consumers?**

— **LAND** That's a definite maybe. It's no longer a matter of either/or – it's the "and" that's important. We have to do both – push and pull, create demand and apply pressure. Pressure is coming from climate change and congested roads, but also from digitalisation and automation. Those who fail to digitalise and network will not be in a position to automate. Those who don't automate will fall victim to digital Darwinism and put themselves at an economic disadvantage.

— **HOLM** For companies, the ball is clearly in their court. Along with protecting the environment, companies need to improve the transparency of all the partners in their supply



**Peter Holm**

Professor Peter Holm is Vice Dean of the Department of Economics at Provadis School of International Management and Technology in Frankfurt. His research and teaching focus on logistics and supply chain management, digitalisation and sustainability.

**“In some areas, we will need to bid adieu to the way things used to be.”**

PETER HOLM

► chains and deliver increasingly customised, customer-focused services. New (cyber-physical) systems and AI will help them do it.

**How green is logistics today? Could it be any greener right now?**

— **HOLM** It could be much, much greener. The question is, what makes companies work toward sustainable supply chains? Pressure is increasingly coming from society and from innovative start-ups. But we need a high-level discussion of this topic. Freight transport will see double-digit growth. That’s why companies need to think about future solutions today. It’s also important for companies to waste no time looking for partners and specialists and to rethink their business models.

— **LAND** One thing is abundantly clear: in the business world, we have paid attention to social issues but not as much to the environment. We’ve been standing still for the last 30 years; there hasn’t been enough pressure. But now we’re at a tipping point, where the trend is moving towards an eco-social market economy. What we are seeing

right now was triggered by Fridays for Future, and it’s just the beginning. I believe awareness is rising at all levels. The economy will follow ecology. Every company will ensure that it becomes more sustainable, or risk being left behind.

**What role do sustainable logistics play in meeting climate targets?**

— **HOLM** A hugely important one. If we consider that the majority of all goods are transported by road, then logistics becomes an obvious issue for climate protection. We also need to bear in mind that more and more people are being drawn to urban areas. How will goods be transported there in the future? Politicians will certainly discuss bans on lorries, but above all we have an opportunity to think innovatively about how we can better establish hubs and parcel stations.

— **LAND** Taking a look at Germany’s total CO<sub>2</sub> emissions – some 800 million tonnes in 2019 – we know that transport and logistics account for roughly 165 million tonnes of them. That’s why we should definitely make logistics more sustainable, but we

## Karl-Heinz Land

Karl-Heinz Land is a keynote speaker, coach, self-proclaimed out-of-the-box thinker and author of the books “Earth 5.0” and “Digital Darwinism”. His latest booklet on how the novel coronavirus is changing our future is available as a free download:

<https://karlheinzland.com/new-purpose/>



shouldn't think that's the whole battle. Every individual needs to do their part.

**In your opinion, what should logistics services look like going forward, and how much logistics can we even afford?**

— **LAND** The most important thing is to establish smart systems and multi-modal platforms. We need systems that put out as little CO<sub>2</sub> as possible as well as renewable energy sources. But we also need human intelligence to avoid unnecessary transports like returns in e-commerce. We have to completely rethink things and ensure that logistics for the last mile remain highly efficient, and that we aren't driving to a single destination five times.

— **HOLM** I'm with you there. Smart systems will support this shift. This model requires very highly trained specialists, but also means we need to decentralise production into regions. The coronavirus has prompted some questions, like is it really necessary to fly everyday items halfway around the globe? The issue of linking different modes of transport is vital for the

future, as is openness to innovation. Green logistics will definitely pay off over the long haul.

**What is the most important issue companies need to tackle and implement now?**

— **LAND** As I see it, one of their biggest levers is the platform economy, i.e. introducing intelligence into their systems. Digitalisation is also important, along with preventing goods from being transported unnecessarily. We'll need technological progress to achieve that.

— **HOLM** Companies should first understand the importance of current and future challenges so they can develop the right kinds of sustainability and digitalisation strategies and think them all the way through. Sustainability shouldn't just be a buzzword; all its ramifications must be fully understood and implementation must proceed accordingly. Companies should be open to engaging in more partnerships. After all, sustainability is not a short-term campaign with a quick payoff. In some areas, we will need to bid adieu to the way things used to be. ●

**“We'll all be very grateful to Greta some day.”**

KARL-HEINZ LAND



# Act. Shift your cargo. Now.



**Globalisation and capitalism have brought great prosperity, but sometimes the environment is left to foot the bill. A shift in the mindset of consumers has long been underway, and politicians and companies are rising to the occasion, too. Find out what has to happen to meet climate targets and how the entire DB Group is working for more sustainability and environmental friendliness.**



— Freight trains transport consumer goods with up to 95% fewer CO<sub>2</sub> emissions than aeroplanes.

**N**owadays we're living in the lap of luxury: wherever we go, we can buy food from anywhere in the world whenever we want it – not only when it's time for the harvest. Trains, planes and ships transport fruit and vegetables directly to us from overseas. Given today's eating habits, it would no longer be possible to keep everyone supplied without these long transport routes, because regional foods would fall short of feeding even a third of the world's population. That is the conclusion of an international study led by Aalto University in Finland and published in the journal "Nature Food". Depending on the type of crops studied, only 11–28% of them are able to cover human needs within a radius of 100 kilometres. Almost everywhere, foods have to be transported over long distances. For instance, 26–64% of them are consumed more than 1,000

kilometres away from where they are produced. The implications for the environment are grim.

### Subsidies increase rail freight transport's appeal

That's because the volume of goods being transported will continue to climb. But how can we come to grips with this rising tide of goods? Space is in short supply, and the roads are packed. Seeing as long transport routes are essential, the only feasible way out is to move traffic onto rail, a greener option that will lighten the load on the roads and the seas. As it stands now, rail accounts for only 18% of the total freight transported in Germany. A comprehensive climate protection programme from the German government has set targets with a view to shifting traffic to more environmentally friendly modes of transport: starting in 2021, climate-busting CO<sub>2</sub> will be

taxed. According to estimates, this step will trim road traffic emissions by 40–42% by 2030 compared to 1990 levels. Renewable energies, rail and electric mobility, meanwhile, are to receive subsidies. The German federal government and Deutsche Bahn aim to invest EUR 86 billion to expand and promote the rail network by 2030. The value-added tax on long-distance train tickets was discounted to 7% at the beginning of the year, while the air traffic levy is increasing to prevent dumping prices. The expansion will also raise the appeal of rail freight transport, enabling significantly more goods to shift to trains.

Businesses are increasingly stepping up to protect the climate, too. They are feeling the pressure from consumers. The way foods are produced plays a role in consumers' purchasing decisions. Companies are thus deferring to rising demand for sustainability. A petition by Oatly, a manufacturer of substitute dairy products, which calls for all foods to have CO<sub>2</sub> labels on their packaging, has been signed by around 57,000 people. Alongside nutritional values, manufacturers would also need to disclose how much greenhouse gas their products emit.

### Everyone should have access to rail

Sigrid Nikutta, Board Member for Freight Transport at Deutsche Bahn and CEO of DB Cargo, can imagine a similar seal of quality for the transport of goods. After all, why make products sustainably only to then pour tonnes of CO<sub>2</sub> into the atmosphere to transport them halfway around the world? "My dream is for everyone to have a great sense of environmental awareness. I want us to be able to stand in the supermarket and look at a seal that tells us our granola travelled by green transport operated by DB Cargo."

Rail freight transport can make a massive contribution to meeting ▶

# DB Group's measures for the climate

## TRANSPORT: HOW GREEN ARE YOUR MEANS?



For the first time ever, the latest version of EcoTransIT World makes it possible to calculate the energy consumption, CO<sub>2</sub> and pollutant emissions of every freight transport worldwide and for all modes of transport. Calculate the environmental footprint of your transports at

<http://www.ecotransit.com>



— It doesn't get any greener than this: cycling to the train.

### DBeco plus

DB Cargo's DBeco plus product enables carbon-free freight transport on all routes in Germany and Austria. DB Cargo determines exactly how much energy a given transport requires, then buys that amount of green electricity from renewable sources. Ten per cent of the revenue brought in by DBeco plus goes to fund facilities that produce or store renewable electricity. DB Cargo issues certificates certifying the CO<sub>2</sub> savings.

### DBeco neutral

The DB Cargo product DBeco neutral compensates for unavoidable CO<sub>2</sub> emissions during transport, such as in pre- and onward-carriage by lorry. The supply chain's total CO<sub>2</sub> emissions are also calculated. Customers can decide how much of the emissions to offset. Together with its partner, atmosfair, DB Cargo then invests in appropriately selected sustainability projects in accordance with the rigorous CDM Gold Standard.

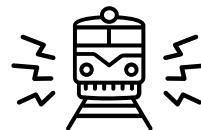

**Cutting railway noise by 50% by the end of 2020**

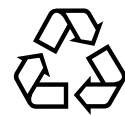

**Reaching a 95% recycling rate by the end of 2020**

### Partnering with atmosfair and Gold Standard

atmosfair is a climate protection organisation focused on mobility. Unavoidable CO<sub>2</sub> emissions can be offset by payments. The funds go to certified climate protection projects. [www.atmosfair.de](http://www.atmosfair.de)

The Gold Standard was created by the WWF and other NGOs in 2013 to better align climate protection projects with environmental protection and sustainable development. The Gold Standard sets requirements for projects to maximise their positive impact. [www.goldstandard.org](http://www.goldstandard.org)



**Protecting animals and plants**

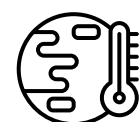

**Climate neutral by 2050**



► climate targets. “In Germany we have something that many envy us for: single wagonload traffic. We have nine big marshalling yards and shunt at over 100 locations in the country. This means that we can move rapidly to combine single wagons into trains in an environmentally friendly way and transport them throughout Europe,” Nikutta adds. But the railways are far from their full capacity at present. That will change. Whether or not it has its own rail siding, every company should be given access to the railways. In order to make this add up for businesses, further transshipment terminals are to be built, where goods can be loaded from road to rail. DB Cargo also offers bespoke solutions to help companies such as binderholz shift more traffic onto the railways (read more on the next double-page spread). This modal shift strategy goes hand in hand with big investments in new technology, such as modular freight wagons and digital automatic coupling (DAC).

### End-to-end climate protection at the DB Group

The entire DB Group has committed to a strong rail system for the sake of the climate. The DB Group has adopted over 150 measures as part of its commitment to climate, nature and resource protection and reductions in noise pollution. The Group’s Advanced TrainLab, the laboratory of the future, is testing technical, environmentally friendly innovations directly on moving passenger trains. The laboratory is trying out a novel diesel fuel, for example. The alternative fuel is produced exclusively from residual and waste materials from vegetable and animal fats.

Food and drink on passenger trains is becoming more sustainable too: no longer will the leftovers from Deutsche Bahn passengers languish in the rubbish bin; they will be donated to a good cause instead. Since February 2020, customers have been able to buy sustainable bottles of Share mineral water from the on-board bistros of long-distance trains. The proceeds go to fund the construction of wells to supply potable water worldwide. What’s

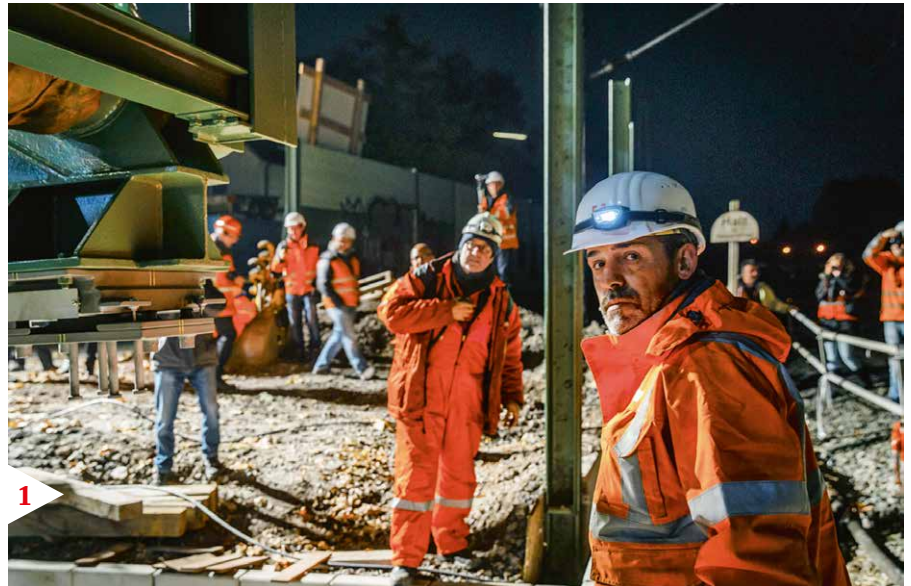

**1** — The DB Group is building for the environment.

**2** — The Group aims to halve railway noise by the end of 2020.

more, new half-litre reusable bottles are making their debut, saving around 38 tonnes of plastic waste on trains per year over conventional reusable bottles. The DB Group is pressing forward with the change in mobility elsewhere too. Together with the country’s Environment Ministry, Deutsche Bahn plans to create 100,000 additional parking spaces for bicycles at German railway stations as part of its Bike+Ride campaign. To achieve this, it is providing DB-owned space to local authorities and municipalities rent-free.

“We have set ourselves the task of decarbonising mobility. In doing so, we are assuming responsibility for the environment and our society: We are strengthening the railways in Germany by creating more capacity and rethinking mobility in green terms – for the climate, for people, for the economy and for Europe,” explains Nikutta. “But for us, green is far more than just an attitude. It shapes what we do.” ●

# Training for climate protection

**T**aking the train is environmentally friendly, and it is even climate-neutral with green electricity. However, energy remains a precious resource. This is why DB Cargo's drivers are trained in energy-efficient driving techniques by DB Training, Learning & Consulting. They are shown how timetables, driving and route dynamics, rolling stock technology and their own behaviour all come together to affect energy efficiency.

## Cutting energy consumption by 10%

The driving simulator is the most important tool for this training. Here, comparison runs are carried out under real conditions. The simulated runs help the drivers to understand the interaction between timetables, driving and route dynamics, rolling stock technology and their own behaviour and put these principles into practice to improve energy efficiency. The participants receive an analysis of the results to help them optimise their driving in a targeted manner. The analysis is put in terms of euros and cents to demonstrate the energy savings. Comparing drivers who have already received the training with those who have not shows that the courses promote climate protection: Those who have practised energy-efficient driving ultimately consume around 10% less energy by avoiding unnecessary starting, braking and accelerating. ●



— Cologne-Dellbrück: In the 2.2-tonne train simulator, a single mouse click switches on snow, fog or heavy rain.



**T**oday, diesel locomotives are still being used in single wagonload transport in order to haul freight wagons to customers' private sidings. While more than 60% of the railway network is electrified, a combustion engine is usually the only way to overcome the last mile to the customer. By 2030, DB Cargo aims to equip 70% of its diesel locomotive fleet with innovative drive systems, and by 2050 the DB Group even intends to replace all diesel vehicles.

## 17,000 fewer tonnes of CO<sub>2</sub> per year

The new Vectron Dual Mode electro-diesel locomotives can go either way: they can run with both diesel engines and electrically on routes with overhead lines. This flexibility reduces diesel consumption and CO<sub>2</sub> emissions. The new locomotives will save Deutsche Bahn around 17,000 tonnes of CO<sub>2</sub> every year. The bi-mode locomotive runs with zero local emissions. In addition to traditional operations on customer sidings, which are generally not electrified, bi-mode locomotives will also be able to cover heavier hand-



— *Bi-mode locomotive: The new Vectron Dual Mode saves DB Cargo up to eight million litres of diesel per year.*

over journeys in future that require larger diesel and electric locomotives today. DB Cargo has initially ordered 100 class 248 locomotives. Delivery will start in 2023; the framework agreement allows for a volume of up to 400 vehicles. ●

## ADVANTAGES AND EFFECTS

- Use of locomotives in line with requirements, with adequate power and low energy consumption
- Trains can use electricity under overhead lines, lowering energy costs, reducing noise emissions and significantly improving the carbon footprint
- Increasing the performance of local services under the overhead lines enables both heavier trains and higher speeds, thus ensuring train path availability with increasing network capacity utilisation

# “THINK LESS, IMPLEMENT MORE!”

**Commentary  
by Martin Sigl,  
Logistics  
Manager from  
binderholz**



As the world market leader in cross laminated timber, we produce environmentally friendly building materials, so it is practically a given that we also make our transport green. We have therefore asked ourselves where lorries are really needed and where we can switch to rail. And lo and behold, a heck of a lot can be done: Together with DB Cargo, we were able to put old factory tracks like those in Burgbernheim back into commission. We also adapted existing wagon equipment so that from spring 2021, we will be able to transport freight to our sawmill in Fügen on the narrow-gauge railway in the Ziller Valley. This means that we more than doubled our transshipment capacity for our main plant, rendering thousands of lorry journeys superfluous every year. We were able to get particularly large-volume transports from the sawmill in Kösching up to the northern ports onto rail very quickly. In areas where we previously only used lorries, we now transport entirely by rail. Together with DB Cargo Logistics, we have increased the proportion of logs transported by rail from 20% to 40% within three years. The modal shifts implemented in the last few months alone have helped binderholz avoid around 42,000 trips by lorry per year in the long term, and we are constantly implementing new rail solutions. If all companies did this, the impact on the environment would be profound.

However, it is not enough for the government to invest billions in rail infrastructure. At the same time, it also needs to invest in equipment such as craneable and rail-ready semi-trailers so that existing structures can be used more effectively to get more volume onto the rails. But above all, companies must have the will to shift traffic. It pays to stop the endless rumination and just get cracking. With DB Cargo, you can quickly find creative and economical solutions. ●



Martin Fiebig, key account manager, DB Cargo Logistics  
[martin.f.fiebig@deutschebahn.com](mailto:martin.f.fiebig@deutschebahn.com)



# To the Far East with low emissions

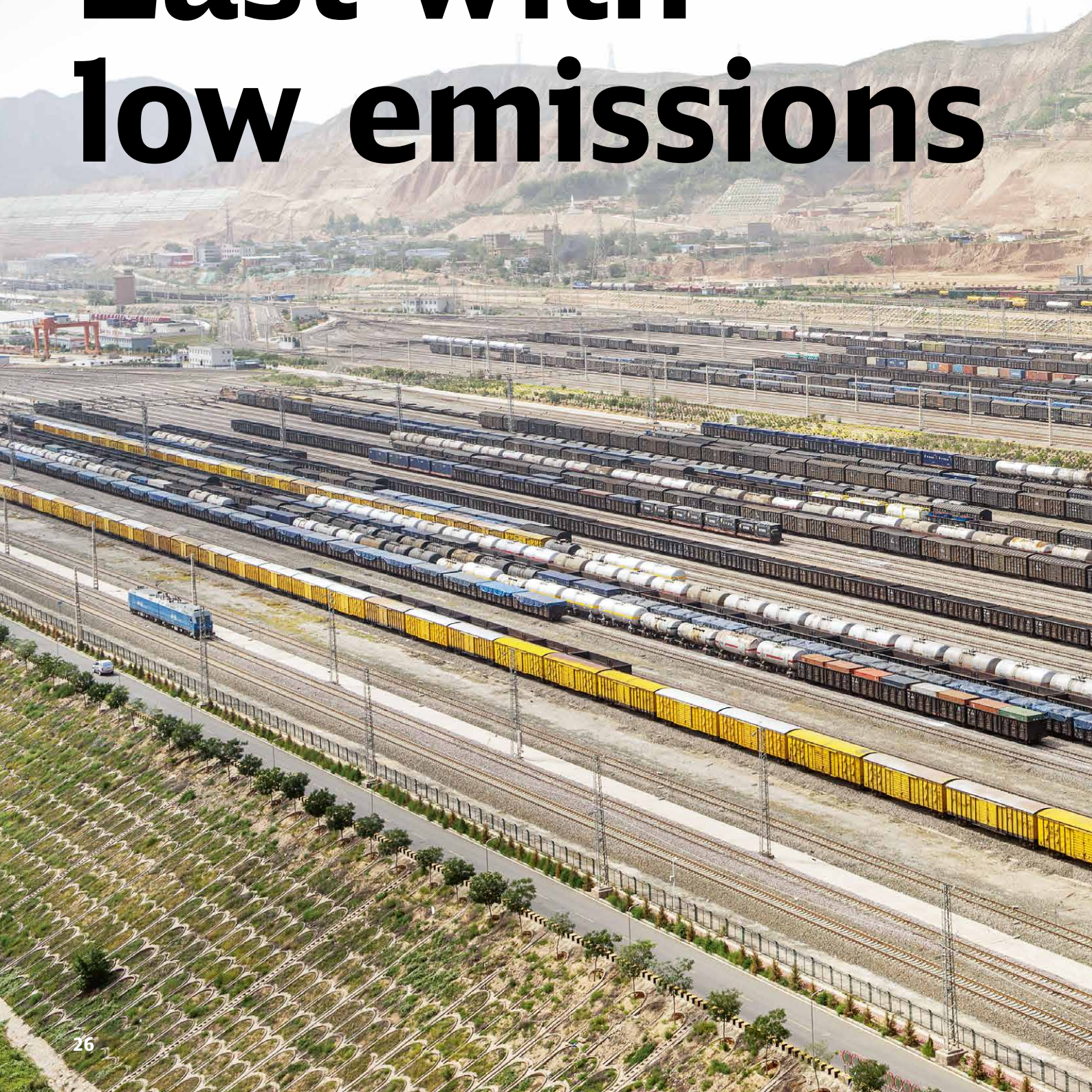





**China wants to be more environmentally friendly. Carbon-free transport of goods to the EU is helping it achieve this goal. DB Cargo Eurasia has been running container trains full of clothing, food and machinery between Europe and China for more than ten years. But rail transport is set to take off, since its environmental credentials far outstrip those of air and sea freight.**

In late September, Chinese President Xi Jinping made an historic announcement: China would achieve climate neutrality by 2060. A hefty ambition considering the country still tops the list of the world's biggest greenhouse gas emitters. Instead of pointing the finger at Western industrial nations, the economic giant now wants to get to work itself. The trans-Eurasian corridor, one of the world's most fascinating globalisation projects, will be a particularly important part of this. China wants to shift traffic to rail to avoid having its exports slapped with CO<sub>2</sub> duties – which the EU is already discussing.

— DB Cargo Eurasia is helping China become more environmentally friendly with low-carbon transports.

Dr Carsten Hinne, Senior Vice-President Corridor Development/Eurasian Corridor and CEO of DB Cargo Eurasia GmbH: “China is expanding rail on a massive scale to mitigate the climate impact of road traffic, among other aims.” After all, no other means of long-distance transport can hold a candle to rail in terms of CO<sub>2</sub> efficiency right now: freight trains emit around 95% less CO<sub>2</sub> than air freight and a third less than road haulage. The figures compare well with sea transport too. If you want to organise intercontinental logistics ▶





**1** — DB Cargo transported 130,000 standard containers on the Eurasian Corridor in 2019.

**2** — Soon a tree will be planted for every container train that travels from Xi'an to Europe.

► chains that are fit for the future, there is no way around rail freight transport.

### Growth despite the coronavirus crisis

Companies have been shifting freight transport to and from Asia onto the rail network for more than ten years now. DB Cargo Eurasia has been hauling containers to and from China since 2008. According to China Rail, a total of 4,329 container trains ran between the EU and China in 2019, more than a 5% gain compared to the previous year. So far, even the coronavirus pandemic of 2020 shows no signs of having halted this growth; on the contrary, about 11% more trains ran from January to April 2020 than in the same period of 2019.

Transit times from China to Europe have steadily reduced over the past few years, as well; terminal-to-terminal times currently stand at 12-14 days. New routes are being added all the time. Since April 2020 there has been a weekly connection from Xi'an via Kaliningrad (rail) to Rostock (container ship) and on to Duisburg, Hamburg or Verona (rail) in 11 to 13 days. This means that rail freight transport between Asia and Europe has developed into an absolutely reliable alternative to air freight, especially now

that deliveries of anti-virus supplies to Europe are on the rise. Rail is quick and green at as little as a tenth of the transport cost.

### Several weekly connections between China and Europe

DB Cargo is looking to further boost its transport capacity. Despite the steady growth, a mere 2% of all freight traffic to and from China currently travels by rail. “DB Cargo carried

around 130,000 standard containers (TEUs) on the Eurasian corridor in 2019. We want to hit the 200,000 TEU mark in 2020. Our target for 2025 is 500,000 TEUs,” says Hinne. From one single train in 2008, capacity has since grown to several connections every week between various industrial centres in China and Europe. By the end of 2020, 2,700 container trains will have travelled from China to Europe and around 1,900 in the opposite direction.







“China is massively expanding rail to rein in the impact of road traffic on the climate, among other aims.”

DR CARSTEN HINNE
Senior Vice President Corridor Development/Eurasian Corridor and CEO of DB Cargo Eurasia GmbH

Planting trees, saving paper

DB Cargo Eurasia relies on partners to further expand rail transport on the Eurasian Corridor and make it even more sustainable. Following an agreement between the operator of the ITL logistics platform and DB Cargo Eurasia in spring 2019, a tree will be planted for each container train that the two partners send from Xi'an to Europe. A whole forest will spring from this spontaneous initiative to document sustainability.

DB Cargo Eurasia is also working in tandem with DB Systel and Deutsche Bahn International Affairs to speed up transports between Asia and Europe even further. In September 2020, the parties discussed the digitalisation of international container transport on the Eurasian Corridor in a meeting with other members of the Seven Railways Agreement. One possible solution: blockchain. Among other things, this could eliminate paper transport documents, making shipments even more environmentally friendly.

RAIL VS. SHIP

Ninety per cent of consumer goods are shipped by sea, severely damaging the environment. Tank containers holding caustic chemicals pollute and destroy the world's waters. They also contribute to dwindling stocks of whales and other ocean mammals; some 45% of endangered ocean species are dying out due to disturbed ecosystems. It is true that a ship can transport more containers than a train. However, overloaded ships and towering waves send roughly 10,000 containers a year tumbling overboard into the depths of the ocean. The environment is clearly better off with rail. DB Cargo Eurasia transports freight with fewer pollutants and is safer and more resilient to inclement weather.

The trains need just under two weeks to carry the containers from Asia to Europe.



Dmitrij Hasenkampf
Sales Director, DB Cargo Eurasia GmbH
dmitrij.hasenkampf@deutschebahn.com

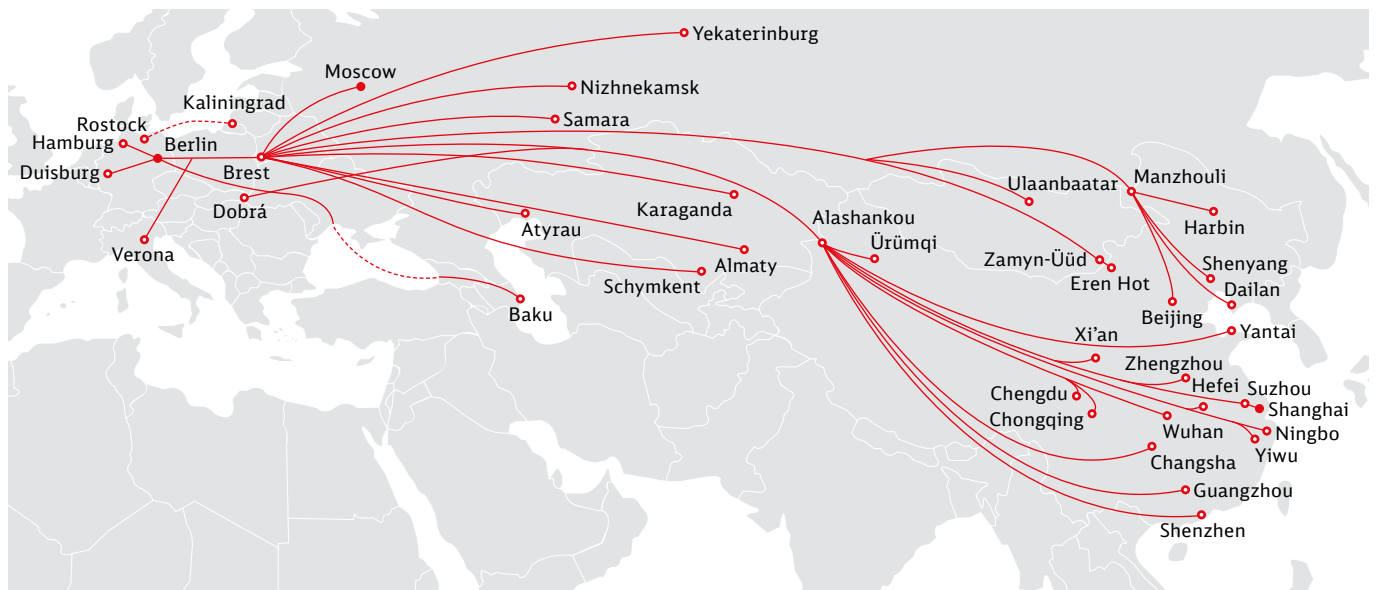

# Goodness, gracious, waste bales on fire!

**Italy is short of waste incineration plants, while Scandinavia lacks warm weather. A clever rail logistics solution for Scandinavian combined heat and power plants uses substitute fuels (RDFs) to turn these two shortages into a win-win situation. The fuels are made out of waste from Italy. The scheme is particularly good for the environment when the fuels are shipped by environmentally friendly rail – all the way from Europe’s far south to the far north.**





**1** — Sweden imports almost a million tonnes of refuse-derived fuel per year.

**2** — So far, roughly half of all household waste in Sweden is used to generate energy.

**Y**esterday's waste is today's refuse-derived fuel. Every year, Italy produces 135 million tonnes of industrial and commercial waste and some 30 million tonnes of household waste. Yet there is a dearth of incineration plants in the country. We produce too much rubbish in Germany, too, and right now it cannot all be recycled. Where to put it all? Rather than simply dumping the waste, it is far more sustainable to unlock the energy it holds. Energy is a valuable commodity in Scandinavia's harsh winters. The region has many combined heat and

power plants that supply district heating for offices, industry and households. Cement plants in the far north also use refuse-derived fuels to save costs on primary fuels. However, Scandinavia's waste alone is not enough to keep the region heated.

#### **RDF on the rails: an offer you can't refuse**

But here's the rub: how do you get the refuse-derived fuel from the centre and south of Europe to the north? Before, the waste travelled by ship or road, with all the damage to the climate that entailed. Now, DB Cargo transports some of the RDFs from Italy and Germany to Denmark and Sweden by environmentally friendly rail.

#### **There's a system behind it**

Trains full of waste do not sound very appealing, but this freight is far less unpleasant than it might seem to the uninitiated. First, the refuse-derived fuels are pretreated in sorting facilities and dried. This is to achieve the right calorific value, which is important for generating energy later on. The waste is compressed into large bales or cubes and then wrapped in foil several times. The cubes are 1.20 x 1.20 metres in size

and weigh around a tonne each. "We are currently transporting around 2,000 tonnes a week from Italy and Germany to the greater Copenhagen area, Aalborg and the Malmö metropolitan area," explains Sandra Pfeiffer, key account manager at DB Cargo.

The flexibility of single wagonload transport is used to avoid having to store large quantities of waste for a long time. Every day or two, wagons stuffed full of RDF bales set off on the long journey to Scandinavia, as far as 2,500 km away. Two- or four-axle sliding-wall wagons with up to 60 tonnes of capacity, or open-top containers, are generally used for transport. DB Cargo also offers additional rail logistics services such as pre-carriage, onward carriage and transshipment. Door to door transport from a single company: that's important, because the shipments need to be traceable—the waste market is tightly regulated. "Here in Denmark, we think that developing new solutions for waste transport is very exciting. When the goods are transported by rail, transshipment and onward carriage by road are always supplied, and we have tailor-made solutions in place throughout Denmark that are capable of delivering up to 750 tonnes a day," says Thomas Vestergaard, Head of International Sales Denmark at DB Cargo.

"DB Cargo has become an integral part of the logistics chain for RDFs from Germany and Italy to Scandinavia. Given our European single wagonload network, predictable turnaround times and close cooperation with our colleagues from the national DB Cargo companies in Italy and Denmark, this set-up gives us a great opportunity to keep up our sustainable growth," explains Marc van der Las, Head of Waste Logistics at DB Cargo. •

## **FAST FACTS**

*RDF power plants primarily serve to provide industrial sites with an energy-efficient power source.*

With refuse-derived fuels that are simple to produce, RDF power plants attain average energy efficiency of above 50%, leaving conventional waste incineration plants in the dust.



Marc van der Las,  
Head of Waste Logistics, DB Cargo  
[marc.van-der-las@deutschebahn.com](mailto:marc.van-der-las@deutschebahn.com)



# These arguments for rail are as strong as steel

Mulde	1	2	3	4	5
Ø min mm	1000	800	1000	800	1000
Ø max mm	2250	1700	2700*	1700	2250
Gew max t	36,0	17,0	45,0	17,0	36,0

\* für Schmalbandcoils: max. Ø 2250

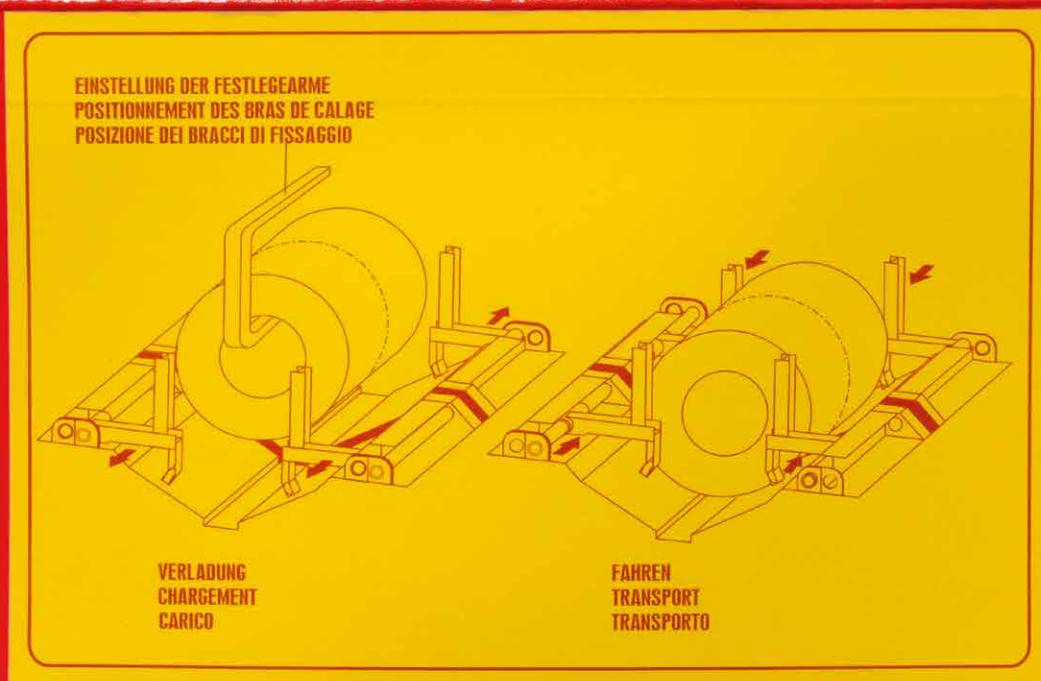

2000

1600

**Large numbers of sectional tubes and special profiles are widely used in the automobile industry, in the generation of renewable energies and in construction. Innovative processes are used to fashion special profiles out of raw materials – steel coils that weigh several tonnes. In addition to being heavy, these coils are also bulky. The Austrian company Welser Profile relies on DB Cargo to deliver them.**

**B**önen lies at the edge of the Ruhr District – in Germany’s “steel country”. Domiciled in the Austrian town of Gresten, Welser Profile Deutschland GmbH also has a site in the district of Unna. After all, Welser Profile is a leading producer of special profiles and special profile tubes in Europe. To date, the company has manufactured more than 23,000 cross-sections. This also means that steel, the raw material needed for the profiles, must keep coming. “Securing an adequate supply of steel is crucial for us,” explains Joern Miklas, SCM Manager at Welser Profile. The raw materials come from sources within a radius of about 300 km, and the bulky and often long profiles are eventually delivered to customers worldwide. At its headquarters in Austria, Welser transports 85% of all inbound shipments by rail. It’s a matter of principle for the company: “As we see it, rail combines sustainability with very solid options for loading and unloading. A single car on the rails replaces two lorries, so you can handle large volumes.”

### More steel on the rails

This is why Welser has its own private siding in Bönen, just like it does in

— The steel coils for Welser profiles are delivered in Shimmns wagons.

Austria. Nevertheless, the proportion of rail transport at the German site is lower. “Until recently, railways could not compete with lorries, especially over short distances,” Miklas says. To change that, DB Cargo is working with Welser Profile to develop new concepts for increasing inbound volumes. “We are optimising journey times, enabling spot services, identifying potential and generating ideas for how to provide service on the last mile,” says Dominik Gerland, customer advisor from DB Cargo’s Regional Sales, explaining the approach. “There’s a lot of potential here. We want to provide our customers with arguments for rail that are as strong as steel.”

### Planning for fluctuations

This is not always easy: Welser Profile’s business can be volatile, depending on the market situation. Routes change and quantities ebb and flow. “There is more volume at the beginning of the week than in the middle. In the era of the coronavirus we’re experiencing now, transports to deliver goods to the automotive industry have fallen fairly sharply,” reports Gerland. “That means we need to adapt our planning and demonstrate a lot of flexibility. This is a challenging environment the two companies are navigating. Step by step, their aim is to approach their goal of seeing up to 70% of climate-friendly transport on rail. Don’t count out long-distance routes in the future, either,” says Gerland. “Welser Profile also supplies products to China. Why shouldn’t rail on the Eurasian Corridor be the alternative to ships someday?” ●

## WELSER PROFILES

*Operating worldwide as a specialist in the development and production of special profiles, i.e. preformed steel components used in machinery, as girder sections for renewable energy facilities or in the construction industry, Welser Profile delivers its products all over the world.*

So far, Welser Profile has manufactured 23,000 profile cross-sections.

85% of all inbound transports to the Austrian location arrive by train.

The company and DB Cargo have a shared goal: 70% climate-friendly rail transport worldwide.



Dominik Gerland,  
Customer Advisor for Regional Sales, DB Cargo  
[dominik.gerland@deutschebahn.com](mailto:dominik.gerland@deutschebahn.com)

# International and flexible

Since the autumn of 2019, DB Cargo Logistics has transported Ford vehicles from Romania all across Europe. Five national DB Cargo companies work closely together to make it happen.

**E**very week, more than a dozen block trains leave the Ford plant in Craiova, Romania, for destinations up to two thousand kilometres away. Located in the Wallachia region of southwestern Romania, Craiova has a rich history and is an important city for European automobile production. In addition to engines, Ford produces the EcoSport and Puma models there. Some of the vehicles go to Constanța, a city on the Black Sea. They are bound for destinations including the Iberian Peninsula. Some of the trains go to Venice to serve customers in Italy. But most of the wagons pass through Hungary and Austria to reach Neuss in Germany, Antwerp in Belgium and Vlissingen in the Netherlands, home of the big Ford hub for the British market.

## A lot of extras

“There are a lot of ins and outs to this job,” says Thomas Pries, account manager for Ford in the finished vehicles unit at DB Cargo Logistics. For one, the

railway uses special freight wagons. They are often too low to transport other car manufacturers’ products, but they’re a perfect fit for Ford’s models from Craiova. The logistics company now has around 400 type 553 wagons in its fleet to transport hundreds of thousands of vehicles a year. “The trains to Northern Europe are almost 700 metres long,” says Alexia Flores, project manager at DB Cargo Logistics. Flores is responsible for designing and implementing the transports and looks after the customer Ford: “Finding the right routes wasn’t easy.”

DB also succeeded in utilising more of the wagons’ capacity. DB Cargo Logistics and its equipment specialists were able to work out a solution for loading each wagon with twelve rather than the previous eleven vehicles, boosting capacity by around 10%.

On top of this, DB Cargo was able to provide additional services, fully taking charge of loading the vehicles in addition to transporting them. In September of last year, DB Cargo Romania began managing finished vehicle logistics at the plant. This task



**“With its five tracks, the plant in Craiova is spectacularly well-poised for rail.”**

**THOMAS PRIES**  
Account Manager,  
DB Cargo Logistics





had previously fallen to Ford's employees. The company hired and trained a team of almost 30 people in Craiova to get the job done.

### Highly flexible

A flexible transport concept now allows planning to factor in sales market fluctuations from the outset and adapts the trains to account for volatile cargo volumes when needed. For this reason, all trains to Northern Europe run through a central hub in Bochum. "Depending on our needs, we can switch between the three destinations

**“Depending on our needs, we can switch between the three destinations of Antwerp, Neuss and Vlissingen.”**

**ALEXIA FLORES**  
Senior Account Manager,  
DB Cargo Logistics

## AT A GLANCE

The trains to Northern Europe are almost 700 metres long and take five days for their journey across the continent.

One freight wagon is loaded with twelve Ford vehicles.

of Antwerp, Neuss and Vlissingen,” says Flores. While the total number of trains to the hub remains largely constant on a weekly basis, the number of trains to specific destinations can vary. When the need arises, it is also possible to transport more than the quantities agreed upon.

It takes the wagons up to five days to travel halfway across Europe: “Right now, we leave 24 hours before the scheduled departure time to allow a buffer for the border crossing between Romania and Hungary,” says Pries. To protect the freight during stops and traffic jams, DB Cargo Logistics has also hired its own security guards in Romania and Hungary. The automaker also sets store in having flexible departures and wagons that are constantly available – including having a few wagons in reserve. Space is available, because Ford has already laid the proper groundwork: “With its five tracks, the plant is spectacularly well-poised for rail,” says Pries. ●



**Thomas Pries,**  
Account Manager, DB Cargo Logistics  
[thomas.pries@deutschebahn.com](mailto:thomas.pries@deutschebahn.com)

**Alexia Flores,**  
Senior Account Manager, DB Cargo Logistics  
[alexia.flores@deutschebahn.com](mailto:alexia.flores@deutschebahn.com)



**1** — Ford has been producing EcoSport vehicles in Craiova since 2017.

**2** — Ford has once more invested heavily in its production facilities for the new Puma.





Stängd-Geschlossen-Zárva  
Öppen-Geöffnet-Nyitva



2-KE-GP-A MAX 2-361 6REV EMO 22.05.72 +9.00m ← T

— From loading to unloading, sliding-wall wagons deliver maximum safety for car bodies.









# A well-received logistics package

Transporting specialist chemicals in single wagon freight traffic to industrial companies throughout Europe – that’s the task DB Cargo BTT is solving for Evonik. With a new transport concept for routes to Switzerland, Austria and Italy, the DB Cargo team has not only maintained existing traffic, but also improved turnaround times to win new transports.

**E**vonik is one of the world’s leading speciality chemicals companies. It is headquartered in Essen, and its largest production site is in the Marl Chemical Park. This and other Evonik sites process thousands of tonnes of chemical raw materials daily, mainly turning them into speciality chemicals. The chemicals are used in numerous everyday products:

car tyres, pet foods, tablets, toothpaste and insulation materials. They often come in small quantities, yet they are critical for the consistency, durability, material composition and efficacy of many end products. This means that many industries rely on a steady supply.

Chemicals, especially liquid ones, are most often transported by rail. This keeps the risk of accidents substantially lower, which is an advantage

## CONCEPT

- ✓ Direct connections
- ✓ High transport frequency
- ✓ Short turnaround cycles
- ✓ Additional services such as shipment tracking, customs clearance, operational and technical fleet management



**1** — *Ideal conditions: Around 100 kilometres of track have been laid at the Marl Chemical Park.*

**2** — *The headquarters of Evonik Industries AG at the Essen campus.*

for dangerous goods, in particular. Like its predecessor companies from which the Group emerged in 2007, Evonik transports much of its freight with DB Cargo. Tank wagons arrive full of starting products and leave the sites full of specialist chemicals. They are transported in numerous single wagons or small wagon-sets to a whole variety of industries throughout Europe.

### New transport concept

Supplying speciality chemicals poses a logistical challenge for the very reason that they are used in such a broad range of fields, since the wagons have to go to a wide variety of sites. Now, a new transport concept is ensuring that Evonik's single wagons reach their destination faster. "Since the beginning of the year, we have focused intensively on corridor development for the chemicals industry on the Switzerland/Italy and Austria corridors," explains Claudia Werk, who heads the Sales and Operations Centre Chemicals 1 at DB Cargo BTT. "In the process, we have run extensive analyses of potential cargo volumes and services to customer sidings, which created a basis for optimisation." This has proven its worth: the weekly transport frequency has



**“We have run extensive analyses to create a basis for optimisation.”**

**CLAUDIA WERK**

Head of the Sales and Operations Centre  
Chemicals 1, DB Cargo BTT

climbed, while round trip times, such as to Italy, have fallen by one to two days. "We achieve this in particular by adjusting the production processes in shipping and using direct connections, which trims turnaround times," explains account manager Silvio Morelli of DB Cargo BTT. Apart from pure transport services, customers can take advantage of other services here, such as shipment tracking, customs clearance or operational and technical fleet management. This means that an industry-specific logistics solution is tailor-made, which also offers potential for other chemical companies to optimise their logistics. ●



**Claudia Werk,**  
Head of the Sales and Operations Centre  
Chemicals 1, DB Cargo BTT  
[claudia.werk@deutschebahn.com](mailto:claudia.werk@deutschebahn.com)

**Silvio Morelli,**  
Account Manager, DB Cargo BTT  
[silvio.morelli@deutschebahn.com](mailto:silvio.morelli@deutschebahn.com)

**3** — *The Marl Chemical Park produces over four million tonnes of basic, fine and speciality chemicals on an annual basis.*

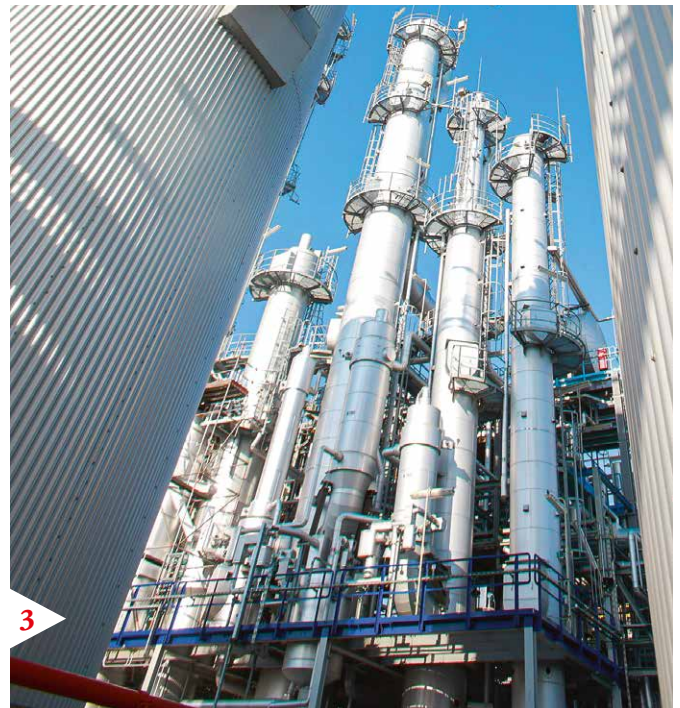



# Running like a well-oiled machine

**What distinguishes a pipeline? Its contents should never stop flowing. This principle is the driving force behind the DBrail pipeline product. As an industry-specific package of services for the mineral oil industry, it combines the industry's need for stability and flexibility with a high degree of reliability and agility in logistics.**

— VARO operates 19 tank terminals in Germany with a capacity of one million cubic metres.



**W**hat do business partners do when they want to persuade their counterparts? They start by asking themselves questions: How can you optimise processes? How can you improve punctuality? How can you increase reliability – in other words, the acceptance rate? Central issues facing the mineral oil business are short-term spot volumes and large-volume transport flows. External factors such as the economy, seasonal fluctuations in demand or regional events have an impact on the business. Events typically unfold differently from expectations; planning horizons are short. Logistics service providers therefore need to show they are flexible. That means resource diversification, short-term loading feasibility checks for spot requests during the year and customised solu-

tions that are tailored to the specific needs of customers. “All these aspects were taken into account and consistently put into practice when **DBrail pipeline** was developed. This was a team effort by Sales, Production and Service Design with a strong commitment to the industry from top management,” explains Janja Pejic-Rost, project manager for **DBrail pipeline**.

DB Cargo BTT has now developed a product specifically for the mineral oil industry in order to meet its requirements even more efficiently. **DBrail pipeline** allows for punctuality and acceptance rates to be agreed on with customers. Its novel feature is a new service design and implementation logic running in the background, which is adapted to the volatile business of the mineral oil industry and has proven itself in several pilot projects. “We did it differently this

---

**“I talk to our mineral oil customers every day in operations. DBrail pipeline is providing our partnerships with a new foundation.”**

**RITA MÖLLER**  
Transport Manager,  
Customer Service DB Cargo

---



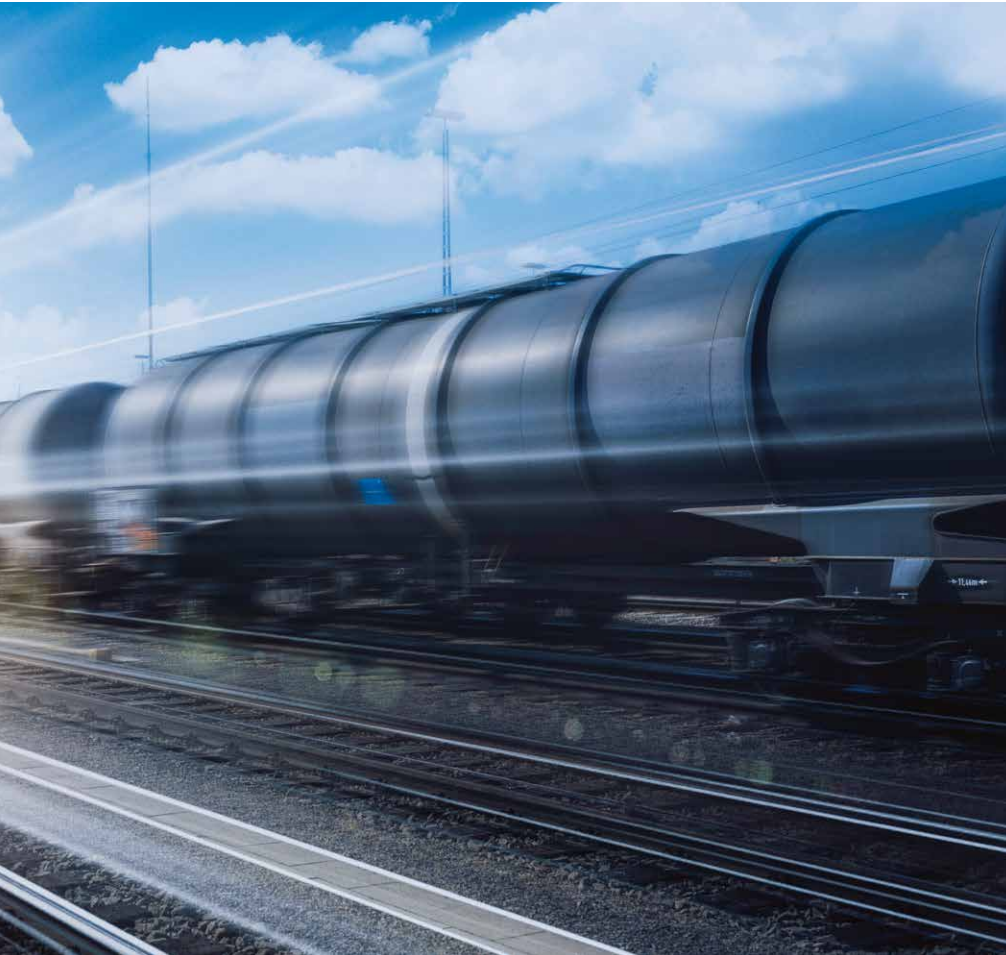

**“For my customers, I have to fulfil the promise of a value proposition. Our partner DB Cargo BTT delivers punctuality, reliability and flexibility. That is crucial.”**

**THOMAS JETZER**  
Logistics Manager  
VARO Energy Marketing AG

time – development was first, followed by a phase of road testing. With verifiable results, we are now introducing our product to the market. All our mineral oil customers will be transferred to **D<sup>B</sup>rail pipeline** by the end of the year, and will benefit from the new processes,” says Gabriele Jansen-Krekels, Head of Mineral Oil, explaining the sweeping change.

#### **Welcome back!**

Open and collaborative. This is how Senior Account Manager Daniel Röder of DB Cargo BTT describes cooperation with Varo Energy (VARO) from Cham in Switzerland. VARO is a mineral oil company operating in Western Europe. It runs refineries, storage facilities and tank terminals. For 2020, the company decided to cooperate with DB Cargo BTT for its transports in Bavaria.

“From the very beginning, we integrated the new traffic into the processes of **D<sup>B</sup>rail pipeline**. The aim was to win back customer confidence through performance. We also overhauled communications,” says Daniel Röder, explaining the change. “Digital solutions enable us to work proactively. We want to offer customers a complete solution for their transports.”

VARO has put DB Cargo BTT’s proposals through their paces. Test trains were run, and there were many discussions. “We have worked with DB Cargo before,” says Thomas Jetzer, Logistics Manager at VARO. “We were recently presented with a completely new concept that won us over. We could see that our partner had done their homework and understood us and our business. The positive experiences we have had together since January confirm this. Initial chal-

lenges were quickly resolved, so now we can focus on expanding our cooperation on digitalisation, for example. We say, “Welcome back!” ●



Gabriele Jansen-Krekels,  
Head of Mineral Oil, DB Cargo BTT  
[gabriele.jansen-krekels@deutschebahn.com](mailto:gabriele.jansen-krekels@deutschebahn.com)

Janja Pejic-Rost,  
Team Leader for Customer Projects, DB Cargo BTT  
[janja.pejic-rost@deutschebahn.com](mailto:janja.pejic-rost@deutschebahn.com)

Daniel Röder,  
Senior Account Manager, DB Cargo BTT  
[daniel.roeder@deutschebahn.com](mailto:daniel.roeder@deutschebahn.com)



# A new era

**Deutsche Bahn and the Volkswagen Group's partnership goes back a long way, and their future together looks bright. DB has become one of the most important service providers for the carmaker over the decades. Today's supply chains are complex, and the logistics specialists at DB use their wealth of expertise and vast network to enable climate-friendly transport between manufacturers, suppliers and customers. This is how Volkswagen and DB Cargo are preparing for the future.**



1 — Every year, around 90,000 wagons hit the rails with vehicles from the VW Group.

2 — Its affectionate nickname “Bulli” became official in 2007. The VW Transporter has been in series production since 1950, however.

One of the products of Germany’s economic miracle was greater mobility. Germans wanted to travel more, and farther afield. And cars weren’t the only mode to gain in popularity in the first few years of the Federal Republic’s existence. Rail grew to become one of the most important service providers for the Volkswagen Group in Wolfsburg. Volkswagen established Wolfsburger Transport-Gesellschaft mbH, now Volkswagen Konzernlogistik GmbH & Co. OHG, in 1965 to coordinate and develop its own transport activities in its growing production network.

Volkswagen is now one of the world’s leading automotive companies and Europe’s largest carmaker. “We offer Volkswagen a range of services that span the entire value chain – including finely tuned just-in-sequence delivery to assembly lines, car transport to seaports and European distri-



bution terminals, and industrial railway operations,” sums up Jens Nöldner, CEO of DB Cargo Logistics. DB Cargo is continuously expanding its existing solutions to be able to transport even more freight and meet the many different requirements of this remarkable company.

**Vast network throughout Europe**

The network that DB Cargo Logistics has created for Volkswagen is truly continental and stretches from Spain and Portugal to Poland, from Norway to Italy and eastward, all the way to the company’s production sites in Kaluga and Nizhny Novgorod, Russia. Cross-border block train and single wagonload service, multi-system locomotives, and smart freight wagons connect 18 warehouses for OEM parts and up to 20 plants that produce the Volkswagen Group’s brands. Volks-

wagen’s component business forwards some 160,000 consignments every year by rail. DB Cargo Logistics provided around 8,500 trains for these shipments in 2019.

Volkswagen’s new vehicles also make their way by train to customers in Europe and overseas. DB Cargo Logistics transported 800,000 new cars in 2019 on its rail network, which connects 14 plants to 30 ports and access points via various hubs.

**Component transport beyond borders**

The enormous complexity of logistics tasks becomes apparent especially when components are transported internationally. Volkswagen needs automotive parts in many different stages of completion to be delivered to its assembly lines. On average, every vehicle consists of around 4,000 ▶

**INBOUND RAIL SERVICE FOR THE VW GROUP**

**Sites for production and OEM parts in Germany**





**3** — *The Zwickau vehicle plant produces vehicles including the fully-electric ID.3.*

**4** — *Sensitive car body parts and batteries are brought directly to the factory in closed sliding-wall wagons.*

► individual components, which are assembled in one place. Since components come from suppliers around the world, supply chains need to be lean and stable and work without hiccups for years on end.

The Volkswagen Group’s brands carefully plan which vehicles to produce and when. Every component plant and every supplier is informed exactly when parts need to be made available for production. Then it’s up to DB Cargo Logistics. Employees at the Components unit in Hanover, for example, make sure that trains transporting components depart on time with the required volume.

Volkswagen’s transports to Russia are an example of a reliable long-running solution. DB Cargo Logistics has transported vehicle components from Germany and the Czech Republic to Kaluga and Nizhny Novgorod, Russia, and coordinated a number of operators and subcontractors since 2007. Trains make the journey from Wolfsburg to Kaluga in five days. The logistics specialists are especially proud of their smart IT solutions, which have streamlined customs and border processes at the border between the EU and CIS in Brest.

The service has been a resounding success. DB Cargo Logistics will trans-

port its 500,000th container from Germany to Russia in 2020. Lined up end to end, the containers would stretch from Berlin to Moscow roughly four times over.

**Just-in-sequence deliveries**

Such close cooperation between a manufacturer and service provider only works if both parties are on the same page and workflows at the plants and in the transport networks are perfectly coordinated. Logistics specialists at the Volkswagen Group and DB developed innovative, integrated solutions that perfectly fit Volkswagen’s requirements for inbound parts and outbound vehicles.

“Ten years ago, we were only able to transport from one private siding to another. For anything more complex than that, customers needed to have their own expertise,” said Kai Birnstein, who heads the Components unit at DB Cargo Logistics. “We now have an extensive network of partners for vehicle transport, access points for transshipping between road and rail, and so much expertise that we’re able to offer efficient integrated concepts,” he added.

Like at the Audi plant in Brussels, for example. Audi began production of

its first fully electric vehicle, the e-tron, there in September 2018. DB Cargo Logistics transports the components for the SUV from the Ingolstadt, Neckarsulm and Győr plants, in the exact sequence they will be needed in Brussels. The finished vehicles are then transported to seaports for export – by rail, of course. “Because the plant is in the middle of the Brussels metropolitan area, there isn’t much room to accommodate stock in house if delays occur,” said Michael Gaschütz from the Components Team. “We really have to be on time.”

The partners have been able to draw on their experience with a similar contract they have had for years. Trains have shuttled back and forth between Ingolstadt and the Audi plant in Győr, Hungary, since 1996. DB Cargo links both plants with high precision and just-in-sequence service every eight hours.

**Fast and flexible for finished vehicles**

DB Cargo Logistics also has the flexibility to respond quickly when it comes to delivering finished vehicles. Volkswagen built private sidings at plants and rail traversers designed specifically to load vehicles, laying the



**“We really have to be on time.”**

**MICHAEL GASCHÜTZ**  
Head of Sales and Operations Centre for Components, DB Cargo Logistics GmbH



groundwork for vehicles to be transported by rail.

“The market’s logistics requirements are changing, and we’re developing new solutions with our customers. Our network puts us in a really good position to increase rail’s share of vehicle distribution in the future,” said Alexander Röckelein from the Finished Vehicles Team at DB Cargo Logistics.

Customer advisers, service designers and dispatchers at DB Cargo Logistics in Kelsterbach manage Volkswagen’s vehicle transports and connect existing concepts with new solutions as they are developed. Single wagons and block trains are combined to create efficient hybrid products. “Only the market leader has the ability to consolidate cargo onto fast and stable trains and supplement that block train system with flexible single wagonload service,” Röckelein said. ▶



## PARTNERING UP FOR SOLUTIONS

**Mr Birnstein, what role does sustainability play in logistics for carmakers these days and what does that mean for DB Cargo?**

It’s not just about eco-friendly cars. Sustainable production is becoming increasingly important for the entire industry. The logistics sector can play a big part, in particular by shifting road transport to sustainable rail. Everyone involved needs to adapt their internal processes as well if we are to reach our climate targets. The willingness is there.

**What transports could be shifted to rail?**

Over the past years, we’ve already had success increasing rail’s share of outbound transport for carmakers. Vehicle transports to unloading terminals that are connected to the railway network are largely handled by rail. New vehicles destined for export are transported from plants primarily on block trains. We also generate growth by offering integrated concepts, and we’re continuously expanding our hubs and network access points and integrating single wagons into our systems. Shifting inbound transport is more difficult because many suppliers do not have a private siding. But Volkswagen is increasingly asking for multimodal solutions and is often the first to use new access points in our automotive network.

**What does that mean for DB Cargo’s relationship with the Volkswagen Group?**

My impression is that contracts will be awarded for integrated solutions, not for individual transports. We’ll need strong partnerships in which the OEM (Original Equipment Manufacturer) develops solutions together with the service provider in joint working groups.



► The DB Group’s extensive resources are a crucial factor in DB Cargo’s ability to offer such high performance. DB Cargo’s national companies work closely together for the automaker, using well-calibrated processes. DB Cargo relies on its partners or DB Schenker, for all-in-one international multimodal solutions. “Many of our services benefit from solutions that we developed with the DB Cargo companies and other DB Group companies,” said CEO Jens Nöldner. “Cooperation within the Group allows us to offer our customers services that are the perfect response to carmakers’ needs.”

**Rolling stock designed for the automotive industry**

Cooperation pays off not only when it comes to international transport solutions; it also plays an important role in the rolling stock, or wagons, that DB Cargo Logistics uses. In the early days, traditional stanchion and flat

wagons were used to transport cars to distribution centres and customers. DB’s predecessor began designing special car transporters back in 1953. The best known is probably the double-decker Off 52, which is even available in miniature from model train maker Märklin.

DB Cargo Logistics now has a wide range of wagons that the Group and some of its close partners developed specifically for transporting certain types of vehicles: wagons with a top loading deck whose height can be adjusted to accommodate SUVs and vans; flat wagons for especially large commercial vehicles; and TT wagons for transporting components, with a headroom of three metres, providing roughly as much space as a lorry.

**It’s down to partnership**

So how is it possible to operate such a large network and offer so many services for a wide range of requirements, and still manage to do an excellent job?

**VOLKSWAGEN HUB IN OSNABRÜCK**

DB Cargo’s hub in Osnabrück plays an important role for Volkswagen transports in the network. Over 50 inbound and outbound trains pass through the hub each week for the Volkswagen Group. Trains heading toward the ports of Emden and Bremerhaven and to import locations in the Netherlands and Belgium pass through the hub as well.

Trains destined for target markets are also routinely routed through other central marshalling yards operated by DB Cargo. There is a reliable daily connection for every plant and every region, whether that’s to Italy via Munich or to Switzerland via Mannheim. Thanks to this European network, DB Cargo can respond quickly when an automaker picks a new exporting port or changes its regional distribution structures.



5

5 — The battery system for the ID.3 comes in closed sliding-wall wagons from the VW factory in Braunschweig.



6

6 — The high-voltage battery has a modular design and contains up to 12 battery modules, each with 24 lithium-ion cells.



7

7 — Going forward, VW plans to make nearly all the body parts for its electric cars itself at the Zwickau plant.



DB does it by partnering with its customers and by using its decades of experience to quickly and reliably recognise what carmakers need. That's especially challenging with Volkswagen, which manufactures cars around the world and is constantly evolving. And that means that logistics has to evolve as well. A driver shortage, stricter rules for drivers and traffic in Germany have made trucks much less flexible than they were a few years ago, for example. As a result, transport solutions that combine multiple modes are now increasingly important.

Then there's the sustainability factor. "Carbon emissions have become one of the most important issues in the automotive industry," said Birnstein. The modal shift is necessary from a climate policy perspective. Transport is much more sustainable when the long main legs are covered by rail, and trucks handle only the first and last mile. DB Cargo's product **DBeco plus** also makes it possible to haul freight 100% carbon-free within Germany and Austria.



The Volkswagen Group is laying the groundwork now for its materials and vehicles to be transported by trains powered entirely by renewable energy beginning in 2021. Once the switch is made, rail transports will cut carbon emissions by over 26,700 tonnes of CO<sub>2</sub> compared to Germany's conventional current mix.

The conversion to electric mobility will bring about a fundamental structural change, not so much on the logistics side, but in terms of the range and design of supply chains. Transports for lithium-ion fuel cells are one example. DB Cargo Logistics is paving the way for a carbon-neutral supply chain for battery and cell module transports. It has developed a rail-based logistics concept with Volkswagen Group Logistics to bring cells from Poland and other countries to German plants, and soon to other locations as well. Simply switching to battery transport by rail will allow Volkswagen to reduce carbon emissions by more than 7,000 tonnes a year beginning in 2021. Protecting the climate is important to the company. Volkswagen Group Logistics' goTOzero impact logistics programme is working on reducing carbon emissions to help reach the targets of the Paris Climate Accord.

### The challenges of the modal shift

If only it were that easy to shift freight from road to rail. International transports have shown time and again that the conditions aren't quite as good for rail transport in other countries as they are in Germany. "Many international routes are not operating at their maximum capacity," said Birnstein. "We should be able to gradually shift more transport to rail." The many railports, terminals, hubs, logistics centres and other track access points that DB Cargo Logistics has established and operates with its partners will help.

In contrast, capacity utilisation along the main routes in Germany is good. Here, digitalisation will help increase infrastructure capacity. Comprehensive digital control will make it possible to up traffic in the network by nearly one-third. Carmakers are already using digital advancements,

## DBeco plus: GREEN TRANSPORT FOR THE AUTOMOTIVE INDUSTRY

Rail is synonymous with environmentally friendly freight transport. And it gets even greener. DB Cargo's customers can opt for **DBeco plus** and reduce harmful emissions even further. Trains are powered by 100% renewable power within Germany, for carbon-free freight transport.

The Volkswagen Group is a pioneer in sustainable logistics in the automotive industry – because it uses **DBeco plus**. From 2021, all DB Cargo's domestic German transports for the Volkswagen Group will be carbon-neutral.

such as artificial intelligence and the internet of things (IoT). The Volkswagen Group connects its 125 plants around the world via a cloud so that it can identify delivery bottlenecks and incidents early on.

DB is also well on its way to taking advantage of these opportunities. State-of-the-art IT systems for ordering, transport monitoring, and billing as well as IoT applications will create efficient, automated processes. But first, current data and sensors are needed. DB Cargo's entire fleet of some 68,000 freight wagons in Germany will be equipped with digital assets by the end of this year to provide information about condition, temperature, humidity and movement.

### Infrastructure in the digital age

DB Cargo intends to use these assets to continuously improve its range and expand its services for the Volkswagen Group. Its prospects are looking good. One thing that's not going to change is its large, European network, which is one of the key advantages that allows it to respond to customer's changing parameters quickly. This highly



**“The market’s logistics requirements are changing, and we’re developing new solutions with our customers.”**

**ALEXANDER RÖCKELEIN**

Head of Sales and Operations Centre for Finished Vehicles, DB Cargo Logistics

► efficient infrastructure, combined with the decades of experience of its employees and state-of-the-art technology, is what will create logistics solutions that will be essential to automobile production and distribution in the future. “We will be able to achieve what we have planned for Volkswagen in the coming years only as part of a close partnership with the company. We need to rethink logistics chains,” said Kai Birnstein. “It’s the start of a new era for us.” ●



Michael Gaschütz,  
Head of Sales and Operations Centre for Components,  
DB Cargo Logistics  
[michael.gaschuetz@deutschebahn.com](mailto:michael.gaschuetz@deutschebahn.com)

Alexander Röckelein  
Head of Sales and Operations Centre for Finished  
Vehicles, DB Cargo Logistics  
[alexander.roeckelein@deutschebahn.com](mailto:alexander.roeckelein@deutschebahn.com)

**8** — DB Cargo Logistics has an equipment fleet for various customer requirements. Its car-carrying wagons are equipped with two loading decks for transport throughout Europe.











## ... a sustainability manager at DB Cargo?

As we all know, rail is one of the most environmentally friendly means of transport. However, that fact is not always very tangible. Meike Hillenbrand and her colleagues help customers, employees, external communicators and, of course, interested members of the public to understand this abstract topic.

**W**e look at the various steps the DB Group has taken to protect the environment. At DB Cargo, alongside our environmentally relevant technical innovations, the chief components of those steps are our eco solutions: **DBeco plus** and **DBeco neutral**. For them, we record CO<sub>2</sub> and pollutant emissions from the various modes of transport throughout the supply chain. Then we identify potential savings for each customer. Not only do our customers who use **DBeco plus** prevent emissions, they also promote the expansion of infrastructure that generates renewable energy. The spotlight in our society is increasingly trained on sustainability, so we are actively positioning rail as an environmentally friendly means of transport. Toward that end, we assist our colleagues from Sales with their

---

**“In the future, sustainability will deliver a competitive edge; it won’t just be a cost factor.”**

---

work. For example, we develop concepts for customer communication and draft presentations for industry conferences. Of course, we present the issue in a way that ensures every one of our 30,000 colleagues always has the right argument for rail at hand, because all of us are making a genuinely important contribution here. We can and should be aware of that fact. Currently, we are working with the business to explore whether we can offer **DBeco plus** in other countries and make it more international. At the end of the day, as Europe’s largest freight operating company, we operate across the entire continent, and every one of our trains reduces CO<sub>2</sub> emissions. •



Meike Hillenbrand, Senior Advisor  
Eco-Solutions, DB Cargo AG  
[meike.hillenbrand@deutschebahn.com](mailto:meike.hillenbrand@deutschebahn.com)



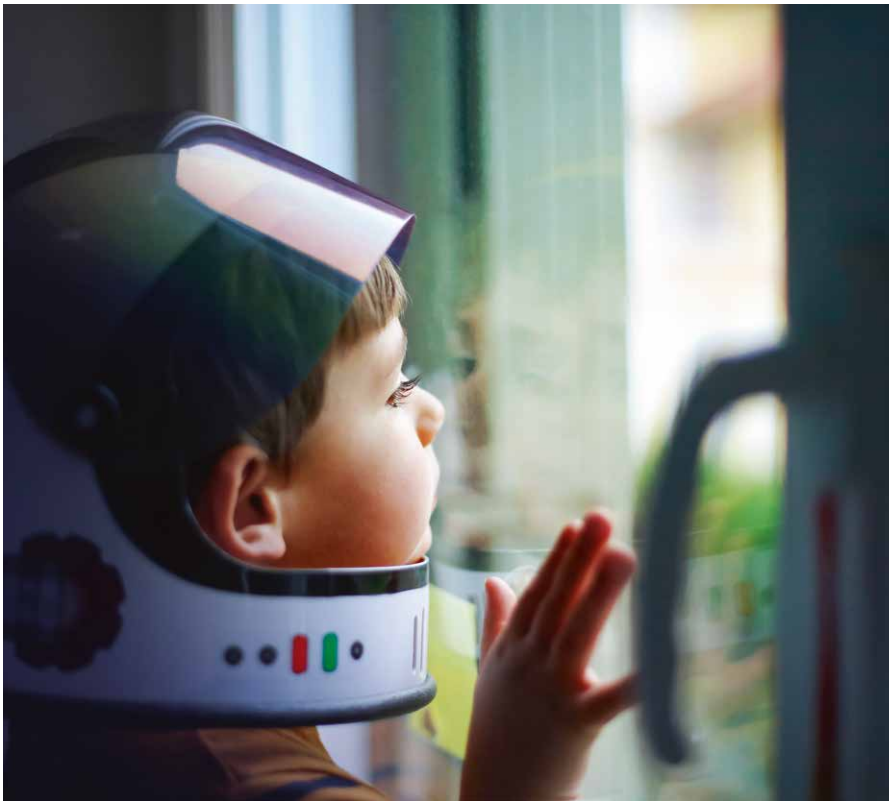

— *The future is what we make of it together.*

// Looking ahead

# TODAY IS A GIFT

**We look to the future with optimism.**

Yesterday is history, tomorrow is a mystery, but today is a gift. Today is a gift, but there's still a lot to do. Today is our chance to shape our future, after all. Yesterday is a year that challenged us in human, political and economic terms. It is also, however, a year that showed us what we still can and must do.

Together, we look to the future with optimism. We can show you how our logistics should look in years to come and the steps being taken by business and policy leaders today. And we'll naturally continue to let you know about the contribution DB Cargo is making – but in different ways.

This is because we aspire to keep developing, too. Keep an eye out, and we'll keep you up to date.



**SUBSCRIBE TO RAILWAYS TODAY**  
*L-Cargo-Railways@deutschebahn.com*

## PUBLISHING DETAILS

### PUBLISHED BY

DB Cargo Marketing  
 Edmund-Rumpler-Strasse 3  
 60549 Frankfurt am Main, Germany

### RESPONSIBLE FOR CONTENT

Thorsten Meffert (responsible under German press law) Vice President of Marketing  
 Anne Günther & Uta Kadow,  
 Heads of Marketing Communication

### PROJECT MANAGER

Zekiye Tulgar  
 +49 (0) 69 265-34439  
 zekiye.tulgar@deutschebahn.com

### CONCEPT/DESIGN/EDITING

MPM Corporate Communication  
 Solutions, Mainz, Germany

### PHOTO CREDITS

Adobe Stock: p. 9 (Cybrain) | Bartłomiej Banaszak: p. 21 | Mathis Burmeister: title page, pp. 4, 10-16, 20 | Ashley Cooper: pp. 2-3 | DB Cargo AG: pp. 28-29, 40-41, 44-45 | Volker Emersleben: p. 23 | Evonik/Karsten Bootmann: pp. 38-39 | Ford Media Centre: pp. 34-35 | Getty Images: pp. 6-7 (Marco Bottigelli), p. 30 (apomares), p. 51 (Catherine Delahaye) | Robert Harding World Imagery: p. 30 | Oliver Killig: pp. 44-49 | BK Media Solutions: p. 22 | Prof. Peter Holm: p. 18 | iStock: pp. 26-28 (zhudifeng), p. 43 (atlantic-kid) | Karl-Heinz Land: p. 19 | Oliver Lang: pp. 2, 5, 8-9, 24-25 | Michael Neuhaus: pp. 23, 36-37, 42 | Philipp von Recklinghausen: p. 24 | Andreas Reek: p. 50 | Oliver Tjaden: p. 25 | Julia Unkel: p. 32

### PRINTED BY

DB Kommunikationstechnik GmbH  
 Akazienweg 9, 76287 Rheinstetten (Bd.), Germany

### ISSN 1867-9668

To protect the environment, this publication was printed on eco-friendly paper.

### DB CARGO ONLINE



dbcargo.com



dbcargo.com/newsletter



DB\_Cargo



company/db-cargo-ag



db\_cargo



dbcargooffiziell



companies/deutschebahn-dbcargoag

[www.dbcargo.com](http://www.dbcargo.com)

### INFORMATION FOR NEW CUSTOMERS

DB Cargo AG, Masurenallee 33  
 47005 Duisburg, Germany

E-mail: [neukundenservice@deutschebahn.com](mailto:neukundenservice@deutschebahn.com)  
 Telephone for new customer information:  
 +49 (0) 203 9851-9000

